

Inverter pure sine wave 6kW



Inverter pure sine wave 6kW



6kW Pure Sine Wave Inverter

6kW Pure Sine Wave Inverter (No reviews yet) Write a Review SKU: PSWI-6KW Weight: 41.00 KGS Add to Wish List

[Get Price](#)

4KW, 5KW and 6KW pure sine wave transformer based inverters

4KW, 5KW and 6KW pure sine wave transformer based inverter have mains charging function and are suitable for various application scenarios such as home, business, outdoor and emergency backup ...



[Get Price](#)



Inverter 48V 6kW Off Grid & Charger , Energetech Solar

This 6kW Hybrid all-in-one, off grid, 48V DC input, 120V/240VAC output inverter is a combination of 145V 80A MPPT solar charge controller, low frequency inverter charger and AC transfer switch.

[Get Price](#)

6KW Hybrid Inverter with MPPT , Pure Sine Wave & LCD

The 6KW/48V Hybrid Inverter (6000W-MPPT) offers top-tier ...

[Get Price](#)

Test certification
CE FCC



6kW Pure Sine Wave Power Inverter - Powerinverter

High efficiency pure sine wave inverter for car & home use, 6000W continuous ...

[Get Price](#)





6000 watt inverter charger

This is a top-of-the-line power inverter, built for the purpose of running your whole house (smaller home), business office or large RV. This inverter charger is perfect for your off grid system or for use as an ...

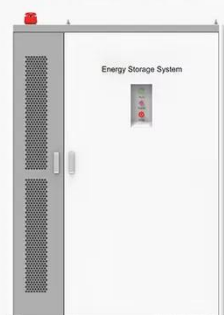
[Get Price](#)

◆ PRODUCT INFORMATION ◆



-  BATTERY CAPACITY
50kWh~500kWh
-  DC VOLTAGE RANGE
400V~1000V
-  DEGREE OF PROTECTION
IP54
-  OPERATING TEMPERATURE RANGE
-10~50°C

Sungold Power 6000W DC 24V Split Phase Pure Sine Wave Inverter ...

The Sungold Power 6000W DC 24V Split Phase Pure Sine Wave Inverter with



Charger ensures efficient power conversion and battery charging for off-grid systems.

[Get Price](#)

6kW Pure Sine Wave Power Inverter - Powerinverter

High efficiency pure sine wave inverter for car & home use, 6000W continuous power and 12000W peak power, converting DC 48V (optional 12V / 24V) to AC 240V (optional 110V / 120V / 220V / 230V), ...

[Get Price](#)

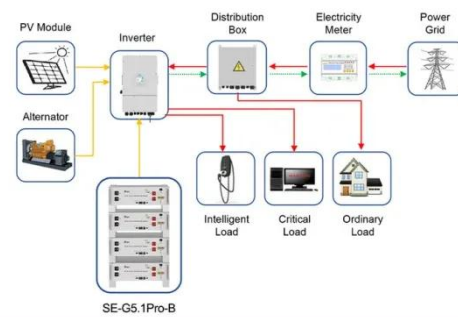

Application scenarios of energy storage battery products

SUPPORT REAL-TIME ONLINE MONITORING OF SYSTEM STATUS

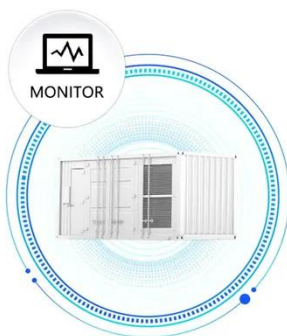

6KW Inverter, Pure Sine Wave Inverter, Solar Inverter

MARS SOLAR is 10+years solar power inverter factory,manufacture 6KW Inverter.More than 3000 successfully case have installed in 130+countries.

[Get Price](#)

SP6KW-48V 6000W Pure Sine Wave Solar Inverter Split Phase 48V ...

6000W Pure Sine Wave Solar Inverter

Split Phase 48V Off-Grid with LED Display
50/60Hz Single Phase Output. o
Maximum PV input current increases to
27A. o Status indication with RGB lights.
o Built-in ...

[Get Price](#)



ixiaer Wave Power Inverter Growatt 48V 6kW 120/240V Split Phase ...

About this item ?This is a multifunctional split-phase output grid solar inverter with a MPPT solar charge, a low frequency pure sine wave inverter and a UPS function module in one machine, which is perfect for off grid backup and self ...

[Get Price](#)

6KW Hybrid Inverter with MPPT , Pure Sine Wave & LCD

The 6KW/48V Hybrid Inverter (6000W-MPPT) offers top-tier power management, making it perfect for modern energy needs. It delivers a pure sine wave output, providing stable and reliable power for ...

[Get Price](#)



Contact Us

For catalog requests, pricing, or partnerships, please visit:
<https://www.cannabiswow.es>

